

80 G-72 2F

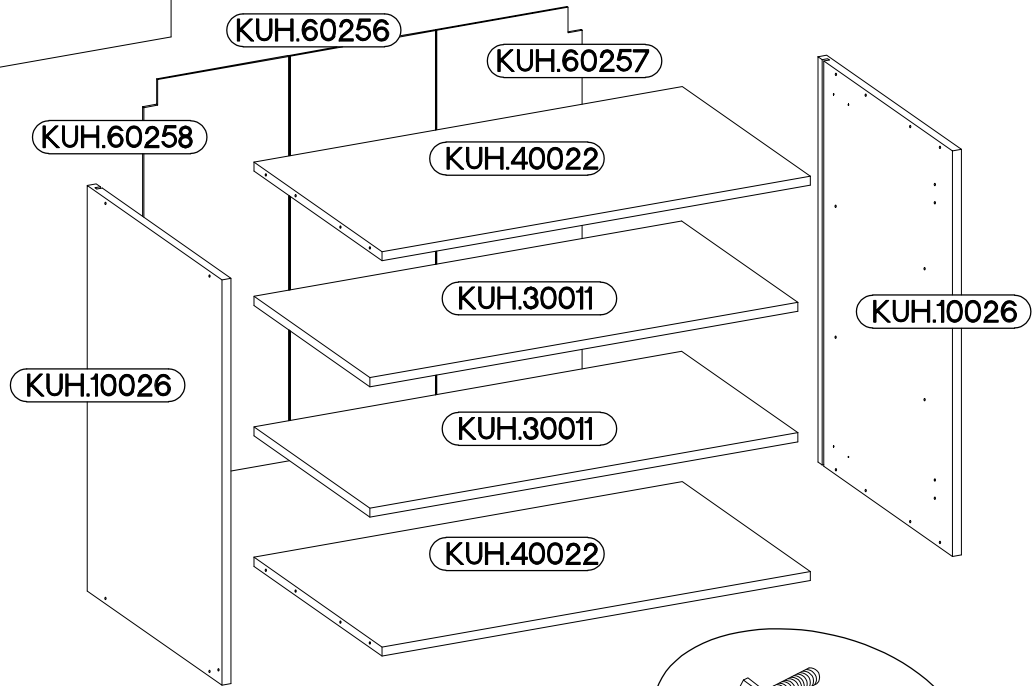

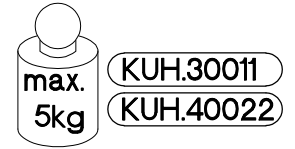
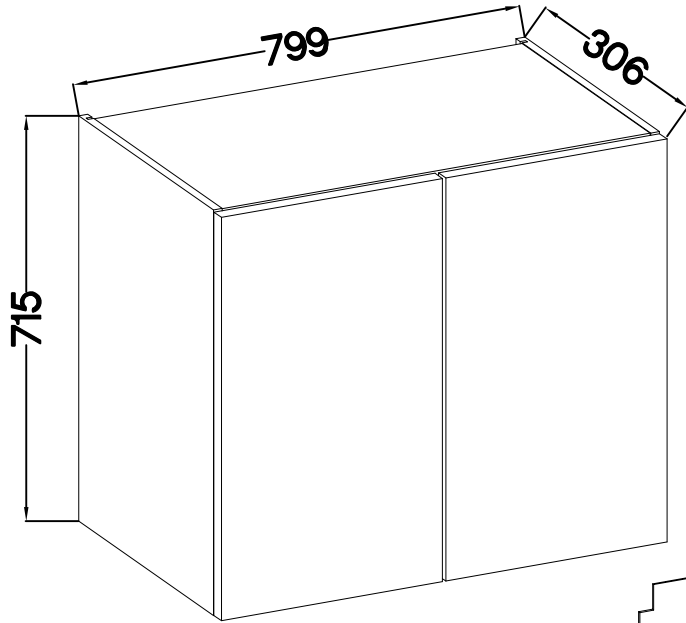
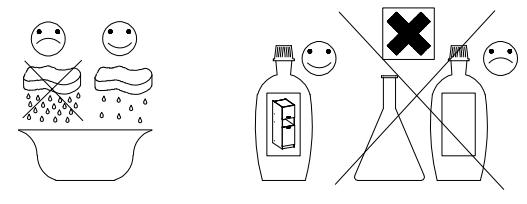
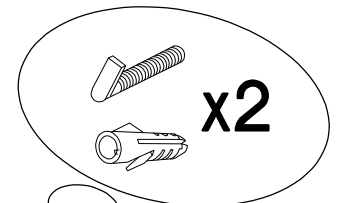

Ersatzteil Nummer	Dimension
KUH.10026 x2	715x290x16
KUH.30011 x2	766x250x16
KUH.40022 x2	767x276x16
KUH.60256	713x260x2,5
KUH.60257	713x260x2,5
KUH.60258	713x260x2,5

$\pm 8 \times 30 \text{mm}$ A	$6,4 \times 50 \text{mm}$ B	E1	$\pm 35 / 0 \text{mm}$ [CD] HG	$\pm 5 / 19 \text{mm}$ J	
8	8	8	4	8	
L1 L1=680mm	K	O	$\pm 3,5 \times 13 \text{mm}$ P5	$\pm 3,0 \times 20 \text{mm}$ P7	$\pm 4,0 \times 30 \text{mm}$ P8
2	2	1	8	15-20	4



ISM-KUH-01631

# 1

 ‡8x30mm A	 ‡4.0x30mm P8	 K
8	4	2

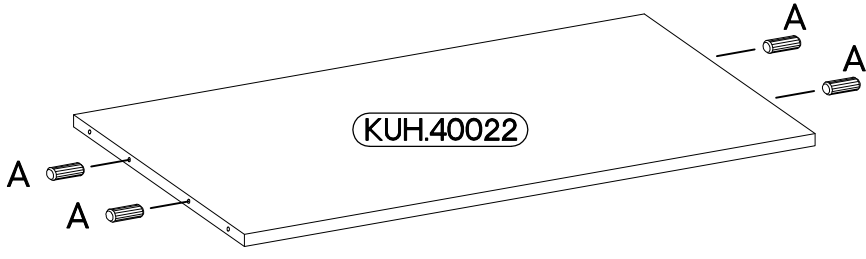
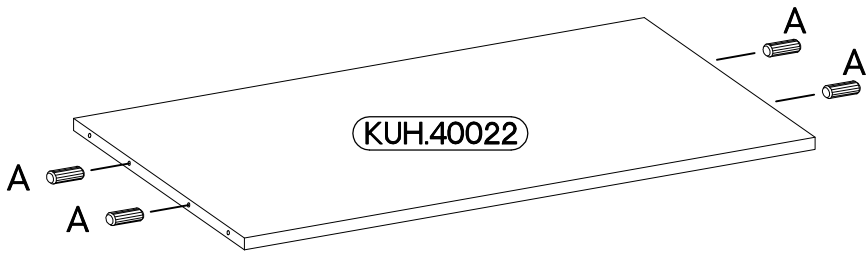
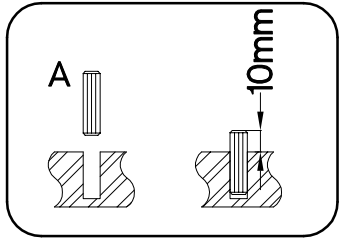
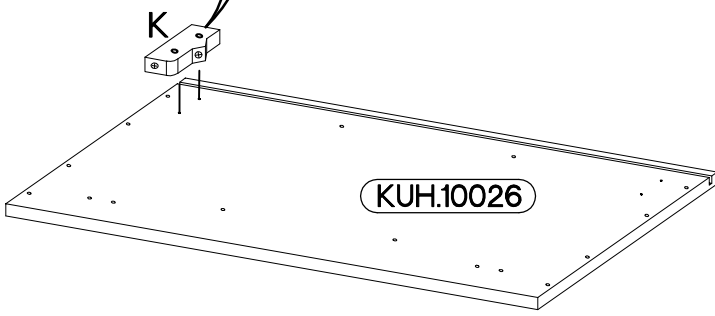
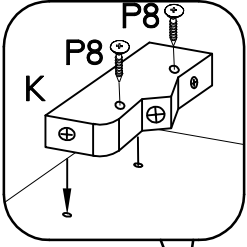
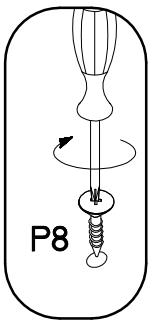
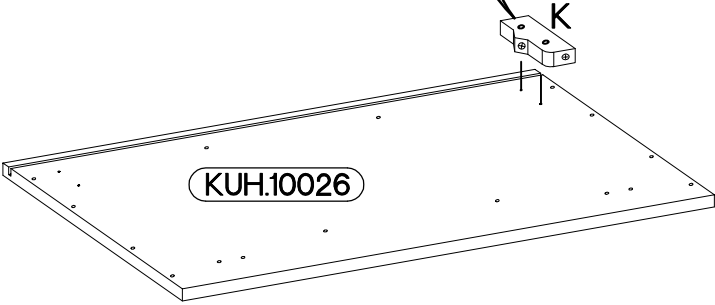
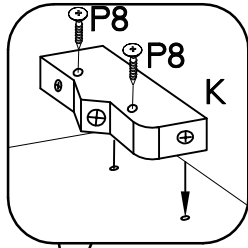
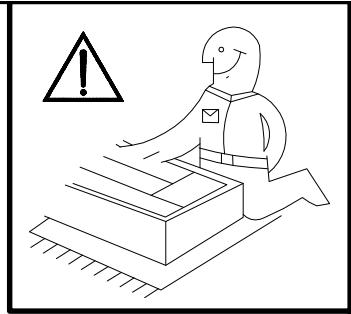

2

6,4 x 50mm

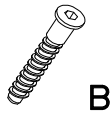

B

4

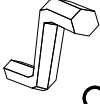

O

1

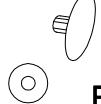

E1

4

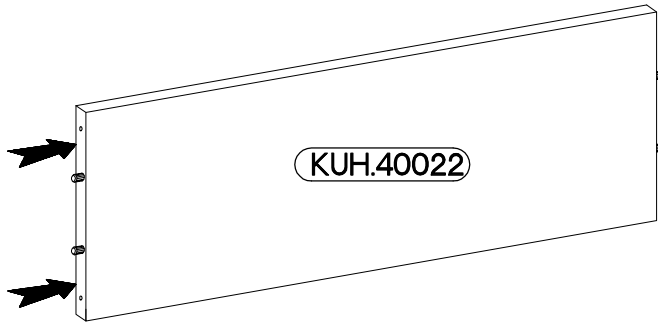
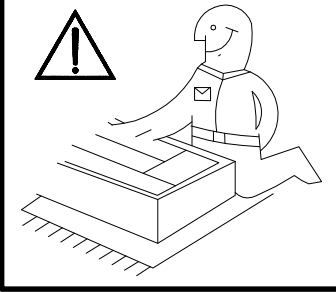

KUH.40022

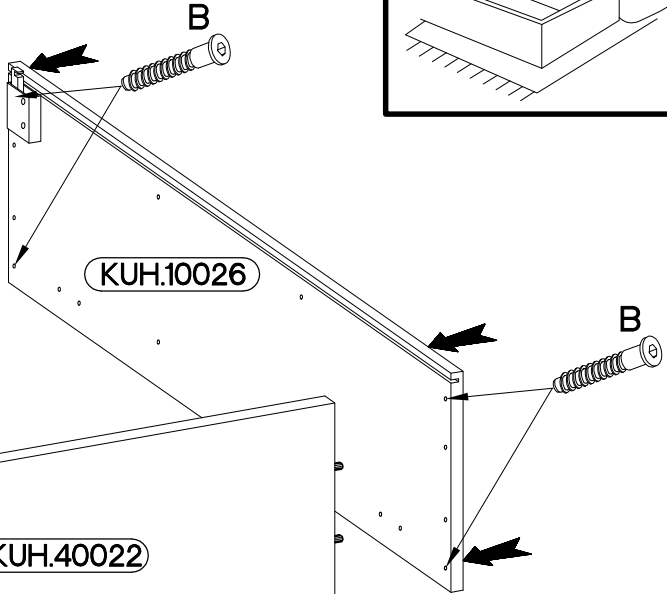

KUH.10026

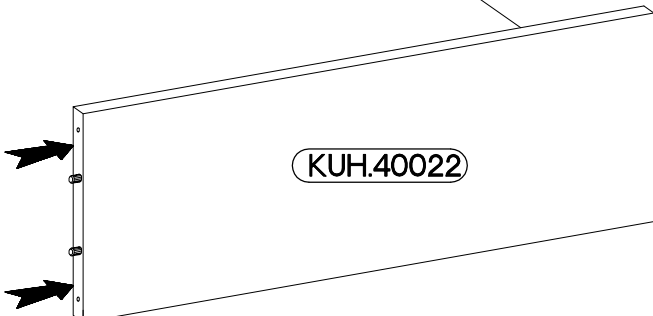

KUH.40022

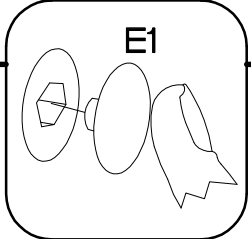
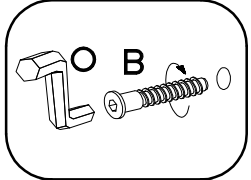

3

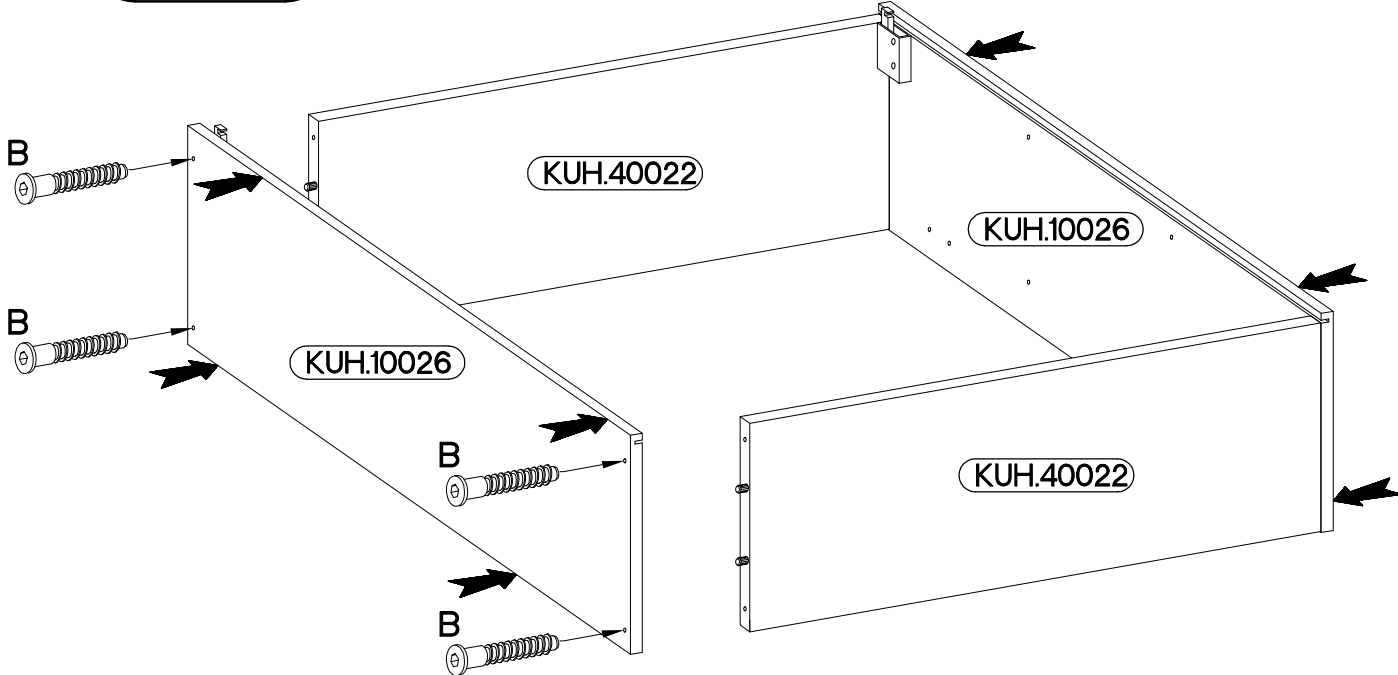

KUH.40022

KUH.10026

KUH.10026

KUH.40022

6,4 x 50mm

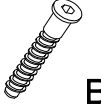

B

4

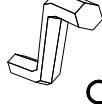

O

1

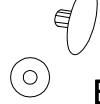

E1

4

4

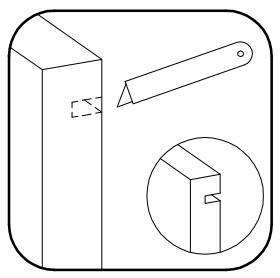
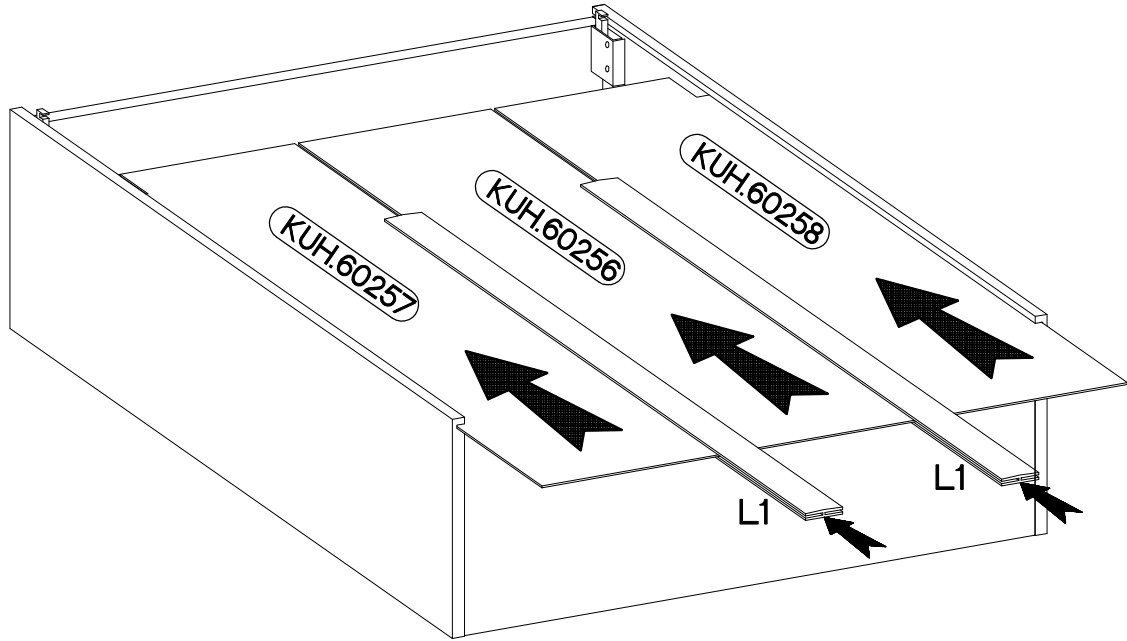
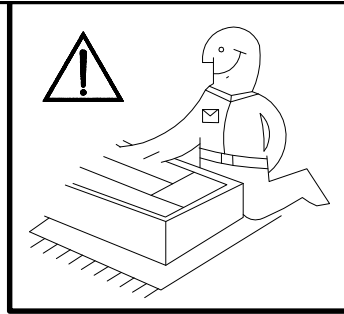
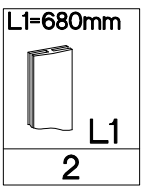

5

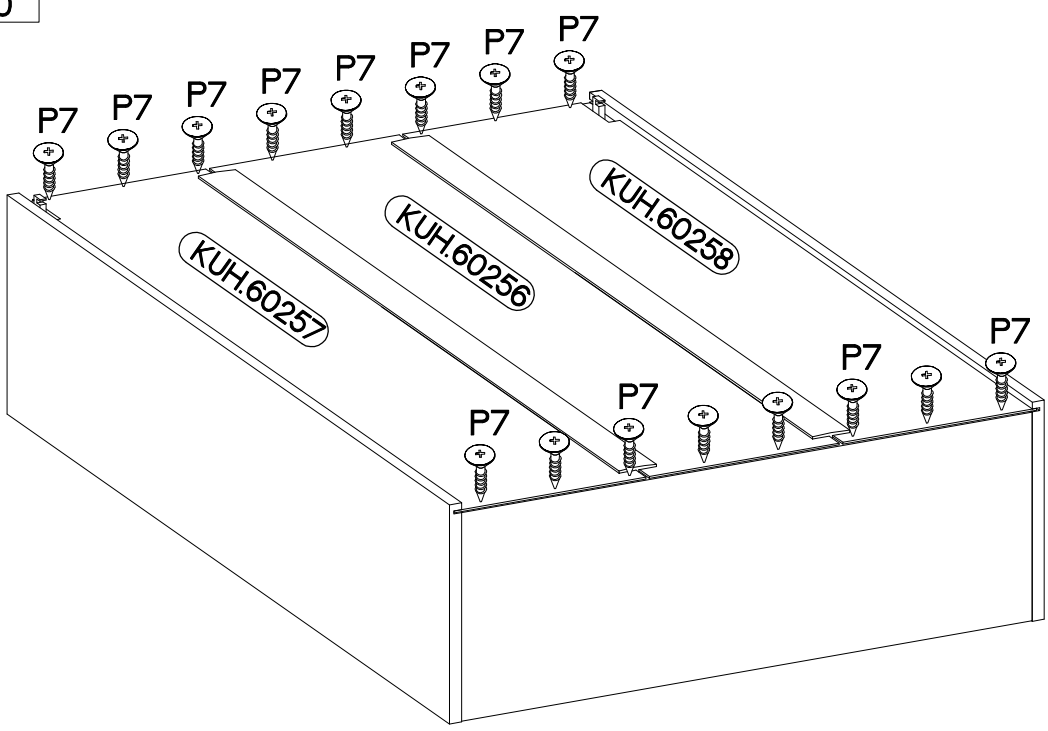
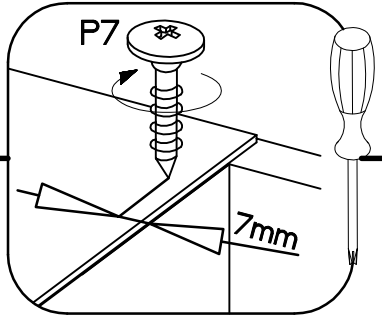
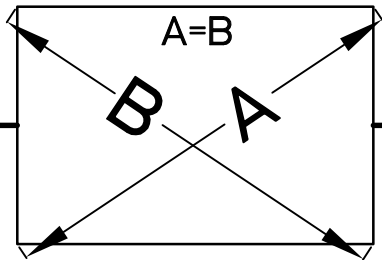
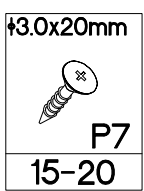

6

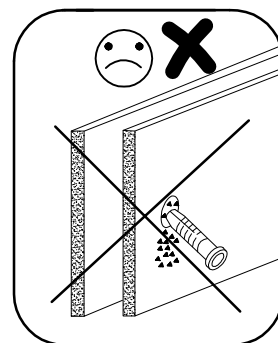
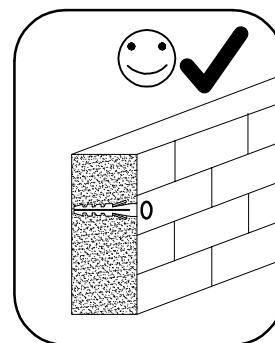
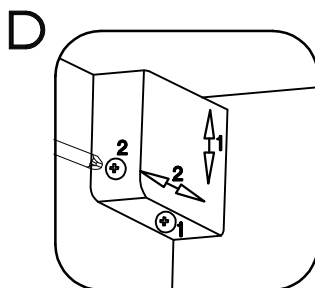
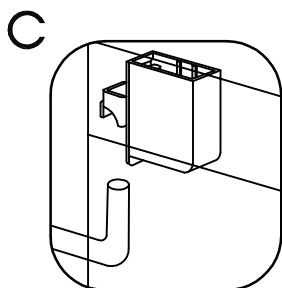
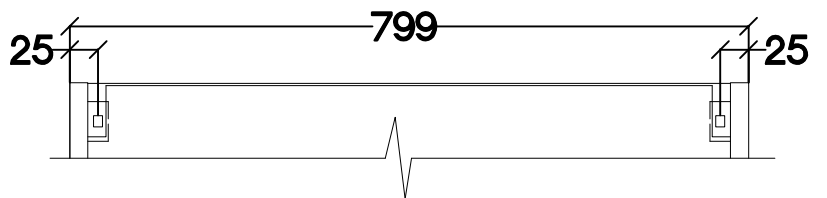
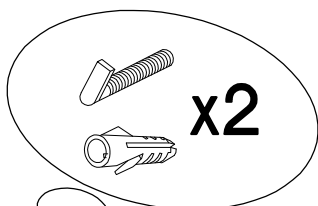
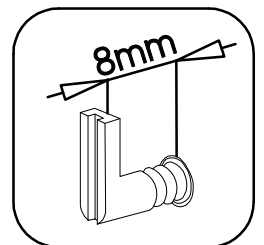
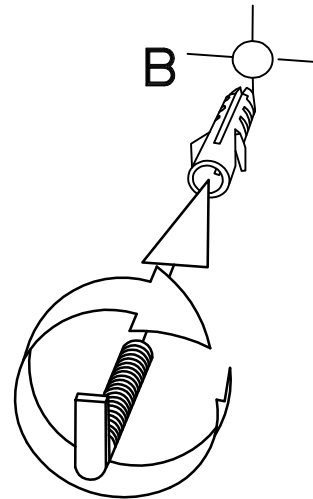
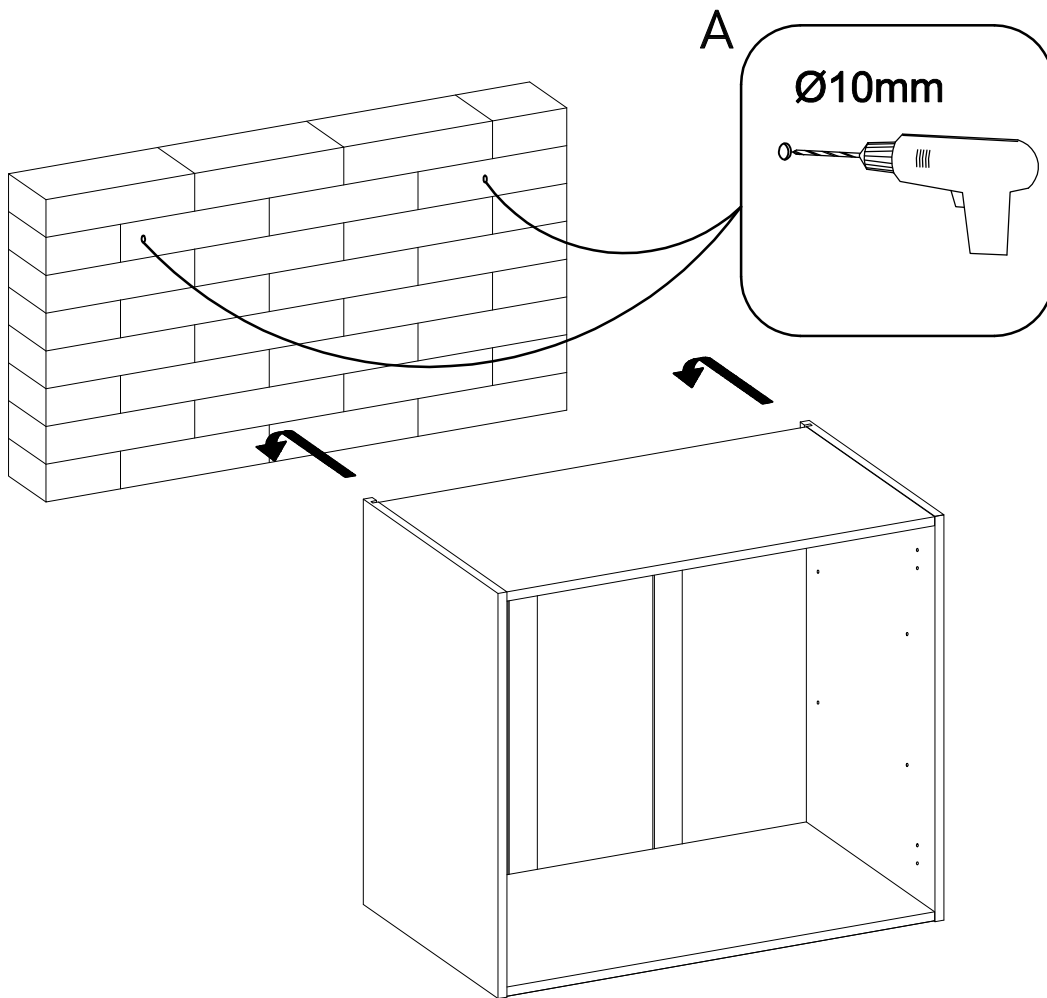
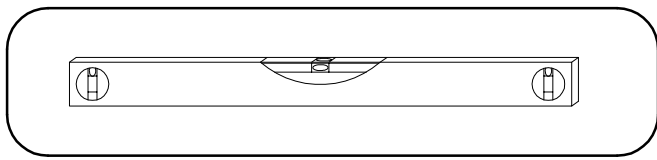

7

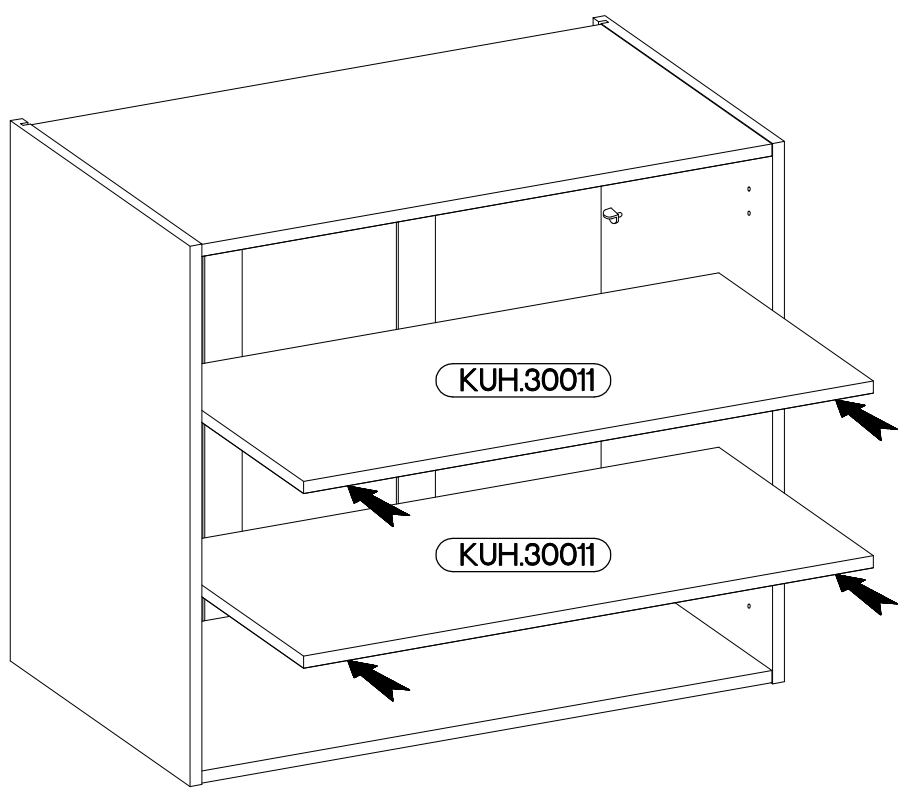
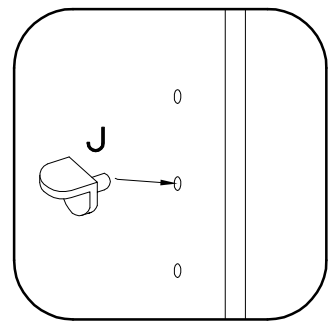
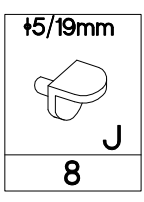

8

FRONT

